

# Smart-VS™

## PRODUCT REFERENCE GUIDE



Smart Vision Sensor

**Datalogic S.r.l.**

Via S. Vitalino, 13

40012 Calderara di Reno (BO)

Italy

Tel. +39 051 3147011

Fax +39 051 3147205

**This manual refers to software version 1.0.0 and later.**

**© 2020 Datalogic S.p.A. and /or its affiliates**

All rights reserved. Without limiting the rights under copyright, no part of this documentation may be reproduced, stored in or introduced into a retrieval system, or transmitted in any form or by any means, or for any purpose, without the express written permission of Datalogic S.p.A. and/or its affiliates.

Owners of Datalogic products are hereby granted a non-exclusive, revocable license to reproduce and transmit this documentation for the purchaser's own internal business purposes. Purchaser shall not remove or alter any proprietary notices, including copyright notices, contained in this documentation and shall ensure that all notices appear on any reproductions of the documentation.

Electronic versions of this document may be downloaded from the Datalogic website ([www.datalogic.com](http://www.datalogic.com)). If you visit our website and would like to make comments or suggestions about this or other Datalogic publications, please let us know via the "Contact" page.

**Disclaimer**

Datalogic has taken reasonable measures to provide information in this manual that is complete and accurate, however, Datalogic shall not be liable for technical or editorial errors or omissions contained herein, nor for incidental or consequential damages resulting from the use of this material. Datalogic reserves the right to change any specification at any time without prior notice.

**Trademarks**

Datalogic and the Datalogic logo are registered trademarks of Datalogic S.p.A. in many countries, including the U.S.A. and the E.U.

Smart-VS is a trademark of Datalogic S.p.A. and/or its affiliates.

**Patents**

See [www.patents.datalogic.com](http://www.patents.datalogic.com) for patent list.

# TABLE OF CONTENTS

---

<b>PREFACE</b> .....	<b>V</b>
<b>About this Manual</b> .....	<b>v</b>
Manual Conventions .....	v
<b>Technical Support</b> .....	<b>v</b>
Support Through the Website .....	v
Reseller Technical Support .....	vi
<b>COMPLIANCE</b> .....	<b>VII</b>
<b>General</b> .....	<b>vii</b>
<b>Power Supply</b> .....	<b>vii</b>
<b>EMC Compliance</b> .....	<b>vii</b>
<b>CE Compliance</b> .....	<b>vii</b>
<b>FCC Compliance</b> .....	<b>viii</b>
<b>EAC Compliance</b> .....	<b>viii</b>
<b>LED Safety</b> .....	<b>viii</b>
<b>HANDLING</b> .....	<b>IX</b>
<b>GENERAL VIEW</b> .....	<b>XI</b>
<b>RAPID CONFIGURATION</b> .....	<b>1</b>
<b>Connect the System</b> .....	<b>1</b>
<b>Mount and Position the Device</b> .....	<b>2</b>
<b>HMI Button Configuration</b> .....	<b>4</b>
Button Teaching Procedure .....	4
Button Incremental Teaching Procedure (optional) .....	5
Button Re-Teaching Procedure (optional) .....	6
System Rollback and Factory Reset (optional) .....	7
<b>Using the Smart-VS WebApp</b> .....	<b>8</b>
Teaching .....	8
Step 1: Image Setup .....	9
Step 2: Acquire GOOD .....	9
Step 3: Acquire NO GOOD .....	10
Step 4: Learn .....	11
Monitoring .....	11
Settings .....	13
Utilities .....	14
<b>INTRODUCTION</b> .....	<b>15</b>
<b>Product Description</b> .....	<b>15</b>
Excellent Performance .....	16
Ease of Setup .....	16
Ease of Use .....	16
Flexible Solution .....	16
Industrial Strength .....	16
<b>Indicator and Keypad Button</b> .....	<b>17</b>
<b>Aiming System</b> .....	<b>18</b>
<b>LED Spots</b> .....	<b>18</b>
<b>Model Selection and Order Information</b> .....	<b>19</b>
<b>Internal Lighting System</b> .....	<b>19</b>
<b>Accessories</b> .....	<b>19</b>

Application Examples .....	20
<b>INSTALLATION.....</b>	<b>21</b>
Package Contents .....	21
Mechanical Dimensions .....	22
Mounting And Positioning Smart-VS .....	24
<b>ELECTRICAL CONNECTIONS .....</b>	<b>25</b>
Power Supply .....	26
Inputs .....	26
Trigger and external push-button connection .....	26
Outputs .....	27
Digital I/O diagram .....	27
Data Valid timing details .....	27
On-Board Ethernet Interface .....	28
<b>TYPICAL LAYOUTS .....</b>	<b>29</b>
Sensor-like Setup .....	29
WebApp for Initial Configuration and Occasional Monitoring .....	30
Setup with Telnet Communication for Job Switching .....	31
<b>READING FEATURES .....</b>	<b>32</b>
FOV Calculation .....	32
Detection Diagram .....	33
<b>MULTI JOB CONFIGURATION .....</b>	<b>34</b>
Job Switching via Smart-VS WebApp .....	34
Job Switching via Telnet Communication .....	35
<b>MAINTENANCE .....</b>	<b>36</b>
Cleaning .....	36
<b>TROUBLESHOOTING .....</b>	<b>37</b>
<b>TECHNICAL FEATURES .....</b>	<b>38</b>

# PREFACE

---

## ABOUT THIS MANUAL

This Product Reference Guide (PRG) is provided for users seeking advanced technical information, including connection, programming, maintenance and specifications. The Quick Reference Guide (QRG) and other publications associated with this product can be downloaded free of charge from the website listed on the back cover of this manual.

## Manual Conventions

The following conventions are used in this document:

The symbols listed below are used in this manual to notify the reader of key issues or procedures that must be observed when using the reader:



**NOTE**

**Notes contain information necessary for properly diagnosing, repairing and operating the reader.**



**CAUTION**

**The CAUTION symbol advises you of actions that could damage equipment or property.**



**WARNING**

**The WARNING symbol advises you of actions that could result in harm or injury to the person performing the task.**

## TECHNICAL SUPPORT

### Support Through the Website

Datalogic provides several services as well as technical support through its website. Log on to ([www.datalogic.com](http://www.datalogic.com)).

For quick access, from the home page click on the search icon , and type in the name of the product you're looking for. This allows you access to download Data Sheets, Manuals, Software & Utilities, and Drawings.

Hover over the Support & Service menu for access to Services and Technical Support.

## Reseller Technical Support

An excellent source for technical assistance and information is an authorized Datalogic reseller. A reseller is acquainted with specific types of businesses, application software, and computer systems and can provide individualized assistance.

# COMPLIANCE

---

## GENERAL

For installation, use and maintenance it is not necessary to open the sensor.

Only connect Ethernet connections to a network which has routing only within the plant or building and no routing outside the plant or building

## POWER SUPPLY

ATTENTION: READ THIS INFORMATION BEFORE INSTALLING THE PRODUCT

This product is intended to be installed by **Qualified Personnel** only.

This product is intended to be connected to a UL Listed Direct Plug-in Power Unit (rated 10 to 30 V, minimum 1 A) marked LPS or “Class 2”.

## EMC COMPLIANCE

In order to meet the EMC requirements:

- connect sensor chassis to the plant earth ground by means of a flat copper braid shorter than 100 mm;
- for direct connections, connect your cable shield to the locking ring nut of the connector.

## CE COMPLIANCE

CE marking states the compliance of the product with essential requirements listed in the applicable European directive. Since the directives and applicable standards are subject to continuous updates, and since Datalogic promptly adopts these updates, therefore the EU declaration of conformity is a living document. The EU declaration of conformity is available for competent authorities and customers through Datalogic commercial reference contacts. Since April 20th, 2016 the main European directives applicable to Datalogic products require inclusion of an adequate analysis and assessment of the risk(s). This evaluation was carried out in relation to the applicable points of the standards listed in the Declaration of Conformity. Datalogic products are mainly designed for integration purposes into more complex systems. For this reason it is under the responsibility of the system integrator to do a new risk assessment regarding the final installation.

#### Warning

This is a Class A product. In a domestic environment this product may cause radio interference in which case the user may be required to take adequate measures.

## FCC COMPLIANCE

Modifications or changes to this equipment without the expressed written approval of Datalogic could void the authority to use the equipment.

This device complies with PART 15 of the FCC Rules. Operation is subject to the following two conditions: (1) This device may not cause harmful interference, and (2) this device must accept any interference received, including interference which may cause undesired operation.

This equipment has been tested and found to comply with the limits for a Class A digital device, pursuant to part 15 of the FCC Rules. These limits are designed to provide reasonable protection against harmful interference when the equipment is operated in a commercial environment. This equipment generates, uses, and can radiate radio frequency energy and, if not installed and used in accordance with the instruction manual, may cause harmful interference to radio communications. Operation of this equipment in a residential area is likely to cause harmful interference in which case the user will be required to correct the interference at his/her own expense.

## EAC COMPLIANCE

Customs Union:

The CU Conformity certification has been achieved; this allows the Product to bear the Eurasian Mark of conformity.

## LED SAFETY

LED emission according to EN 62471.



# HANDLING

---

The Smart-VS is designed to be used in an industrial environment and is built to withstand vibration and shock when correctly installed, however it is also a precision product and therefore before and during installation it must be handled correctly to avoid damage.

- Avoid that the device is dropped (exceeding shock limits).



- Do not fine tune the positioning by striking the device or bracket.

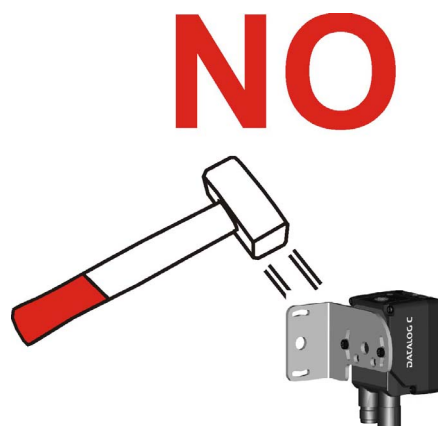

- Do not weld the device into position. It can cause electrostatic, heat or reading window damage.

**NO**

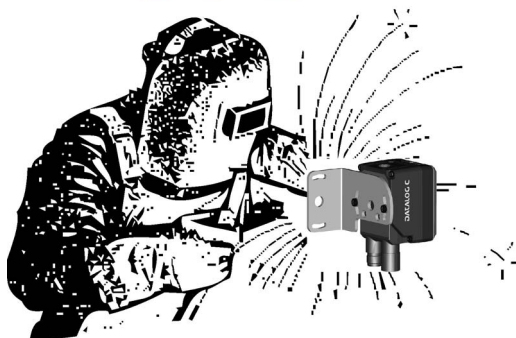

- Do not spray paint near the sensor. It can cause reading window damage.

**NO**



# GENERAL VIEW



Figure 1 - General View

- |  |   |
|--|---|
| <b>1.</b> Bracket Mounting Holes (2)   | <b>7.</b> Power - I/O Connector         |
| <b>2.</b> Power On LED                 | <b>8.</b> Lens                          |
| <b>3.</b> Ethernet Connection LED      | <b>9.</b> LED Aiming System             |
| <b>4.</b> 90° Rotating Connector Block | <b>10.</b> Red Spot (NO GOOD)           |
| <b>5.</b> HMI Interface                | <b>11.</b> Green Spot (GOOD)            |
| <b>6.</b> Ethernet Connector           | <b>12.</b> White Polarized Illuminators |



Figure 2 - HMI Interface Details

HMI CONFIGURATION	
	<b>NO GOOD object</b> <ul style="list-style-type: none"> <li>• in Teach phase: blinking, NO GOOD object teaching</li> <li>• in Run phase: NO GOOD object detected</li> </ul>
	<ul style="list-style-type: none"> <li>• for future use</li> </ul>
	<b>Trigger</b> <ul style="list-style-type: none"> <li>• in Teach phase: trigger input status</li> <li>• in Run phase: trigger received</li> </ul>
	<b>GOOD object</b> <ul style="list-style-type: none"> <li>• in Teach phase: blinking, GOOD object teaching</li> <li>• in Run phase: GOOD object detected</li> </ul>
	<b>Run</b> <ul style="list-style-type: none"> <li>• steady: device in Run phase</li> <li>• blinking: Teaching required</li> </ul>

# CHAPTER 1

## RAPID CONFIGURATION

---

### CONNECT THE SYSTEM

Figure 3 shows an example illustrating how to connect the system. In this layout the result signals are connected to the PLC while it is possible to configure and monitor the device by the Host PC.

The device is activated by an External Trigger (photoelectric sensor) when the object enters its reading zone.

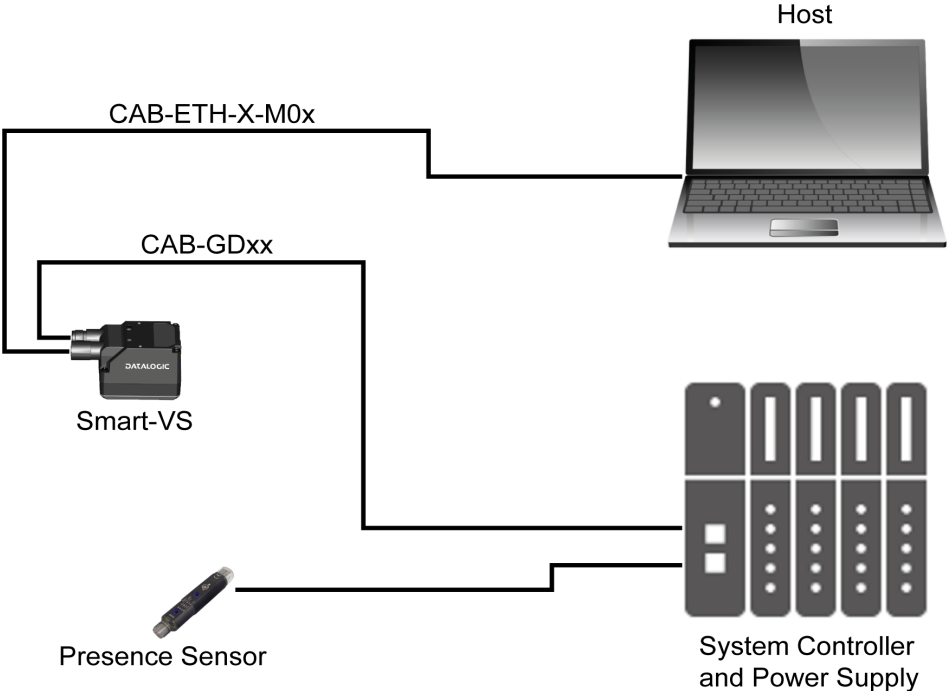

Figure 3 - Smart-VS layout example

## MOUNT AND POSITION THE DEVICE

1. To mount the Smart-VS, use the mounting bracket to obtain the most suitable position for the device. The most common mounting configuration is shown in the figure below.

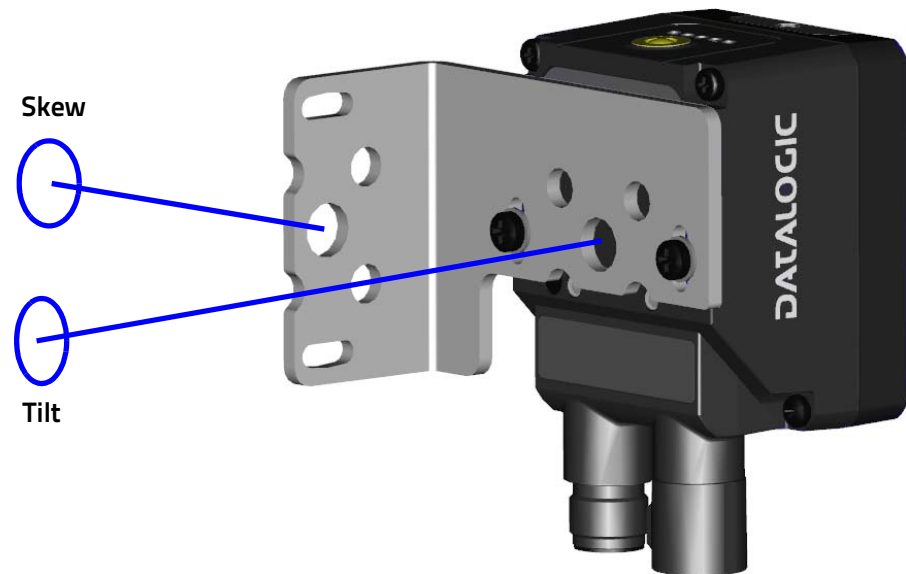

Figure 4 - Positioning with Mounting Bracket

2. When mounting the Smart-VS take into consideration these three ideal label position angles: **Pitch or Skew 10° to 20° and Tilt 0°**, although the device can operate at any tilt and skew angle provided the object feature to be inspected fits into the Field Of View (FOV).



Figure 5 - Max. 20% pitch to avoid direct reflections



**NOTE**

**Rapid Configuration of the Smart-VS sensor can be made either through the HMI interface (see "Button Teaching Procedure" on page 4) which requires no PC connection, or by using the Smart-VS WebApp (see "Using the Smart-VS WebApp" on page 8). Select the procedure according to your needs.**

# HMI BUTTON CONFIGURATION

## Button Teaching Procedure

The Run LED will blink until the Teaching procedure is entered (e.g. device factory default).

Long press (> 4s, until the red LED on HMI lights up) the HMI Button to enter the Teaching procedure.

1. GOOD objects required to be taught (green LED and green spot blink).



2. Place the GOOD object in front of the Aiming System.



3. Place the trigger sensor properly. The Trigger LED indicates object detection.



4. Short press (< 1s) the HMI Button to acquire the image. More than one GOOD object can be acquired. It is suggested to acquire one image per GOOD object instance. Camera parameters are auto-adjusted on the first acquisition only.



5. Long press (> 4s, until the red LED on HMI lights up) the HMI Button to start acquiring NO GOOD objects. The red LED and the red spot start blinking.



6. Place the NO GOOD object in front of the Aiming System. Check the Trigger LED.





- Short press (< 1s) the HMI Button to acquire the image. More than one NO GOOD object can be acquired.



- Long press (> 4s, until the red LED on HMI lights up) the HMI Button to enter the automatic learning procedure (LEDs game). In the end, the device will enter the Run Phase

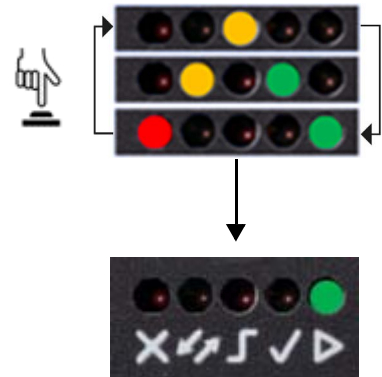

**NOTE**

The Teaching procedure can also be entered when in Run phase: press the HMI Button for 2s (yellow LED on HMI) for incremental teaching or 4s (red LED on HMI) to cancel and re-teach.

## Button Incremental Teaching Procedure (optional)

When in Run mode (Run green LED steady on), training images can be added to the current job.



**NOTE**

It is recommended to perform this procedure via WebApp to have more control over this operation.

- Press the HMI Button for approx. 2 seconds and release it as soon as the HMI yellow LED turns on.



- New GOOD object images can be added to the current job.



If incremental teaching is needed for NO GOOD objects only, skip to step 3.

Short press (< 1s) the HMI Button to acquire a GOOD image.



3. Long press (> 4s, until the red LED on HMI lights up) the HMI Button to start acquiring NO GOOD objects. Red LED and red spot start blinking.



4. New NO GOOD object images can be added to the current job.

If incremental teaching is needed for GOOD objects only, skip to step 5.

Short press (< 1s) the HMI Button to acquire the NO GOOD image.



5. Long press (> 4s, until the red LED on HMI lights up) the HMI Button to enter the automatic learning procedure (LEDs game). In the end, the device will enter the Run phase.

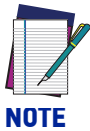
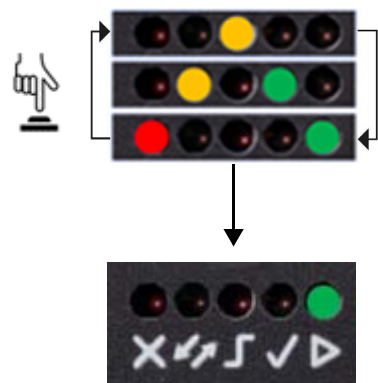

**In case of mistakes, the procedure can be aborted before proceeding to step 5 by pressing the HMI Button for approx. 2 seconds until the HMI yellow LED turns on.**

**NOTE**



## Button Re-Teaching Procedure (optional)

When in Run mode (Run green LED steady on), the current job can be erased and re-trained.

Long-press (> 4s, until the red LED on HMI lights up) the HMI Button to enter the Teaching procedure, then follow the "Button Teaching Procedure" on page 4.

If errors occur and the new Teaching is not finalized, the current job will not be overwritten.



**In case of mistakes, the procedure can be aborted before entering the learning procedure by pressing the HMI Button for approx. 2 seconds until the HMI yellow LED turns on.**

**NOTE**



## System Rollback and Factory Reset (optional)

It is possible to perform a System Rollback to the second to last software version installed or a complete device Factory Reset by pressing and holding down the HMI Button while powering up the device.

For System Rollback, hold down the HMI Button until all LEDs blink simultaneously for about 3 seconds, then release it when they are steady on.

All saved jobs are kept with a System Rollback. Two consecutive System Rollback procedures lead to the factory software version keeping all the saved jobs.

For Factory Reset, hold down the HMI Button until all LEDs blink simultaneously for about 3 seconds, then release and press it again during the LED blinking sequence.

All saved jobs are erased with a Factory Reset.



### NOTE

**It is suggested to close the Smart-VS WebApp before performing the procedures above. Connect to or refresh the WebApp to check the device software version (see "Utilities" on page 14).**

## USING THE SMART-VS WEBAPP

Before using a Smart-VS device, a Teaching procedure must be performed. Teaching can be completed either using the embedded HMI (see [Button Teaching Procedure](#)) or the Smart-VS WebApp graphic user interface.

**NOTE**

**To access the Smart-VS WebApp, Google Chrome is the recommended Internet browser.**

To access the Smart-VS WebApp, connect to the device IP address 192.168.3.100 via Ethernet.

In case of a new device, the user is automatically redirected to the [Teaching Wizard](#).

If the Teaching procedure has already been performed, the [Monitoring](#) page is displayed.

A [Settings](#) page is also available to adjust the device settings.

Device information and the software update feature are available on the [Utilities](#) page.

## Teaching

To perform Teaching on the Smart-VS device, enter a job name, select the bank where to store it, click on the *Create Job* button, and follow the procedure described below.

The screenshot shows a web interface titled "Job Creation Wizard". It contains the following elements:

- A blue header bar with the text "Job Creation Wizard".
- A text prompt: "Please provide a Job name to proceed."
- An input field labeled "Insert a Job name" with a horizontal line below it.
- A dropdown menu labeled "Select Bank" with a downward arrow on the right.
- A grey button at the bottom labeled "Create Job".

## Step 1: Image Setup

On the **Image Setup** page, select the *Start Automatic Setup* to automatically set the Focus Distance, the Exposure Time, and the Sensor Gain parameters (suggested). Alternatively, select *Advanced Image Settings* to manually set the parameters.

It is also possible to move the Field of View based on the application needs, which can be useful when objects of different batch formats must be inspected on the same line. To do this, simply click on the image and drag it throughout the gray area.

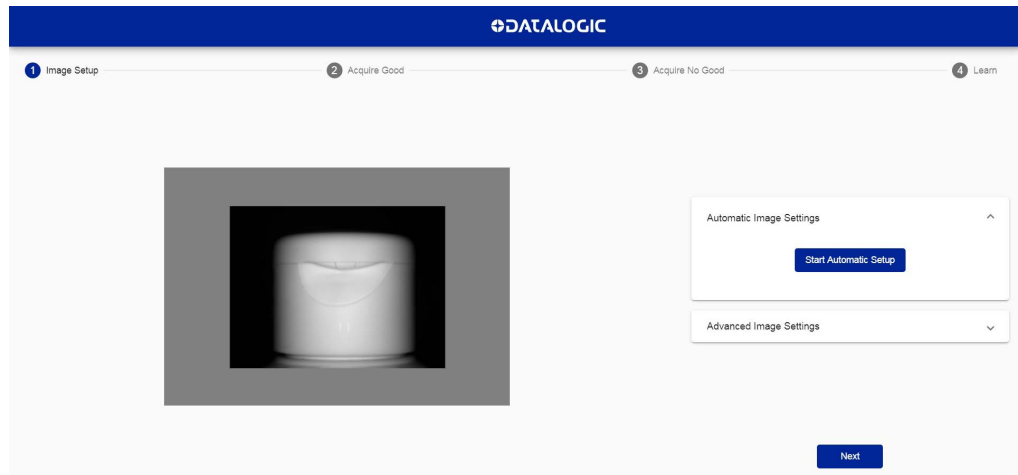

After completing image setup, click *Next*.

## Step 2: Acquire GOOD

On the **Acquire GOOD** page, one or more GOOD objects can be acquired by clicking on the *Teach* button. It is recommended to acquire as many GOOD images as the known number of instances to be treated as GOOD.



**NOTE**

**A maximum of 6 images can be stored in both GOOD and NO GOOD boxes.**

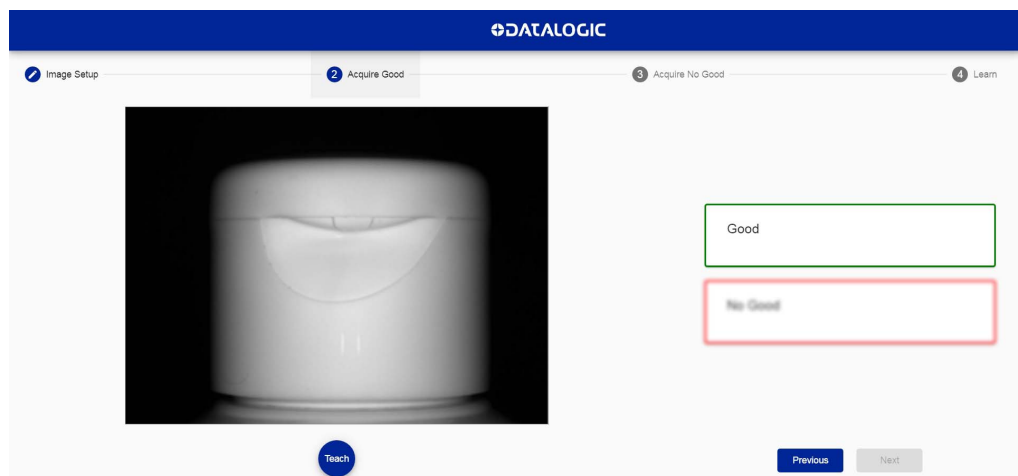



**NOTE**

Click on an acquired object in the **GOOD** box and select **DELETE** to delete it.

After adding at least one object, you can click **NEXT** and go to the **Acquire NO GOOD** page.

### Step 3: Acquire NO GOOD

On the **Acquire NO GOOD** page, one or more **NO GOOD** objects can be acquired by clicking on the *Teach* button. It is recommended to acquire as many **NO GOOD** images as the known number of instances to be treated as **NO GOOD**.



**NOTE**

A maximum of **6** images can be stored in both **GOOD** and **NO GOOD** boxes.

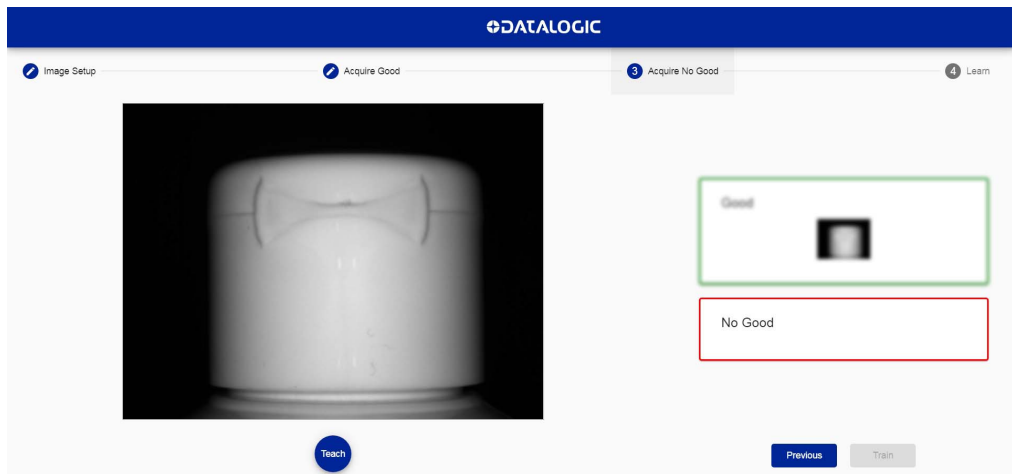

**NOTE**

Click on an acquired object in the **NO GOOD** box and select **DELETE** to delete it.

After adding at least one **NO GOOD** object, you can click on the *Teach* button.

## Step 4: Learn

This step is completed automatically.

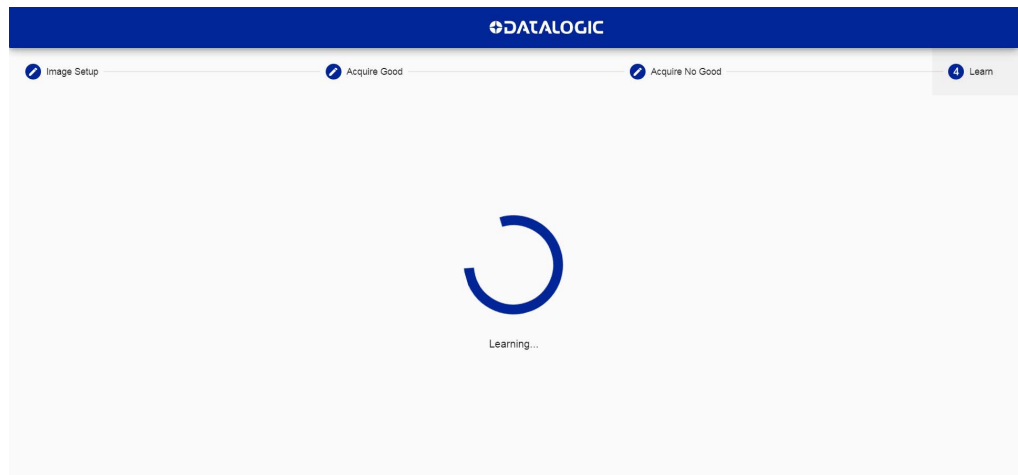

Once the device is trained, the graphic user interface switches to the Monitoring page.

## Monitoring

The **Monitoring** page is divided into an upper bar, a main area, and a bottom bar.

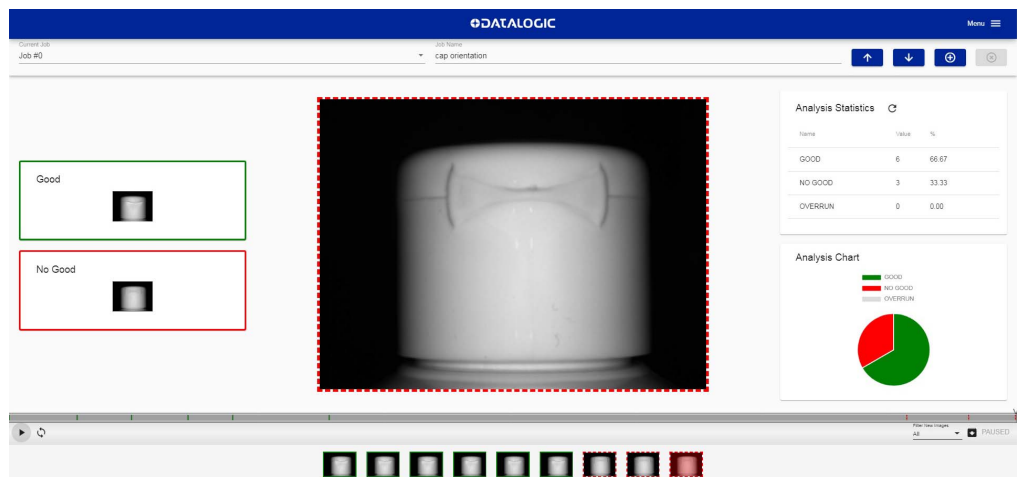



The **upper bar** contains the job name to the left. Use the drop-down menu to switch to another job (if present).



**If you want the selected job to be the running and startup job, click on the *Play* button before leaving the page.**

Next to the job name, the following icons are present:



ICON	DESCRIPTION
	<b>Upload job:</b> uploads a job from your PC (.svscfg file)
	<b>Download job:</b> downloads the current job on your PC

ICON	DESCRIPTION
	<b>Add new job:</b> switches to the Training wizard to create a new job
	<b>Delete job:</b> deletes current job (if only one job is present, this automatically switches to the Training wizard to create a new one)

The **main area** includes:

- the GOOD and NO GOOD boxes to the left;
- the cropping area at the center;
- the statistics box to the right. This shows the statistics concerning the ongoing acquisitions.

The **bottom bar** displays an archive of acquisitions (filmstrip). To start acquiring objects, two options are available:

	<b>Save and Play with External Trigger</b>
	<b>Play with Self-Trigger</b>

The *Play* button is also a *Save* button: click on it before leaving the page to store any change.



**NOTE**

**The *Play with Self-Trigger* button is not an actual operating mode (output signals are not driven). It is only intended for demonstration purposes or preliminary checks in static condition.**

Next to the *Play* icons, the acquisition results are displayed as green bars for GOOD objects, red bars for NO GOOD objects, and gray bars for OVERRUN occurrences.

Click on the *Pause* icon to stop acquisition and enable all available functions.

Dragging the gray box along the bottom bar displays the acquisitions included in that interval. You can now perform **Incremental Teaching**: click on an acquisition and select GOOD or NO GOOD to add it to the corresponding acquisition box. It is also possible to drag and drop acquired images to the GOOD / NO GOOD box or from the GOOD box to the NO GOOD box and vice versa.

After clicking on one of the *Play* icons, the newly added acquisitions will be used by the device in addition to those stored during the initial Teaching procedure.

Furthermore, the Smart-VS WebApp allows image saving. Any image shown in the WebApp can be saved clicking on it and selecting *Save*.



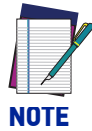

**It is recommended to enable the browser option “Ask where to save each file before downloading”.**

**NOTE**

The following options are also available:

Filter New Images All	Show all images or just one category between GOOD, NO GOOD, and OVERRUN
	Download the entire filmstrip

## Settings

This page contains I/O Settings and General Settings.

It can be reached using the hamburger icon on the upper right corner.

Under I/O Settings two parameters can be adjusted:

- **Trigger Input Delay:** the delay to apply prior to the acquisition process of the trigger event. It is measured in time (ms). This parameter can be adjusted along with image acquisition: images are shown on the related window.
- **Output Hold Time:** the time (ms) during which the output data remains valid.

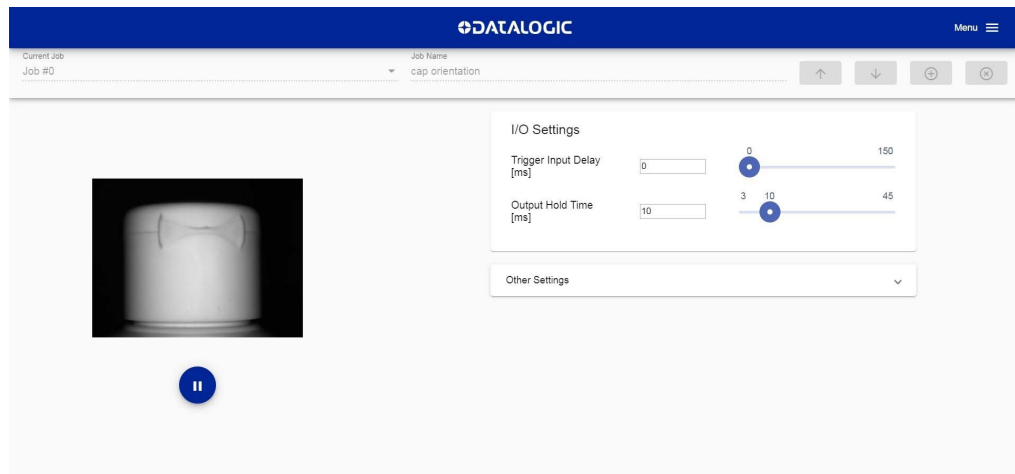

Under Other Settings the following parameters can be customized:

- **Trigger Input Event:** can be either Leading or Trailing.
- **Trigger Input Debounce:** filter debounce time measured in  $\mu$ s.
- **Remote Teach Input Event:** available selections are Leading and Trailing.
- **Remote Teach Input Debounce:** filter debounce time measured in  $\mu$ s.

- **Output Mode:** available selections are NPN, PNP, Push-Pull active High, Push-Pull active Low.
- **Aiming System:** available selections are Always ON, Always OFF, Calibration Only.
- **Green/Red Spot:** available selections are Calibration Only, Enabled, Disabled.

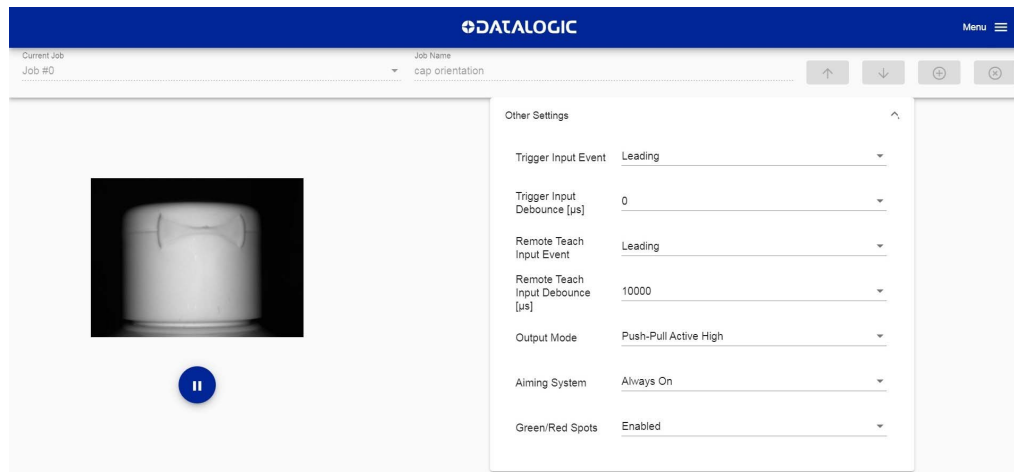

## Utilities

The **Utilities** page can be reached using the hamburger icon on the upper right corner.

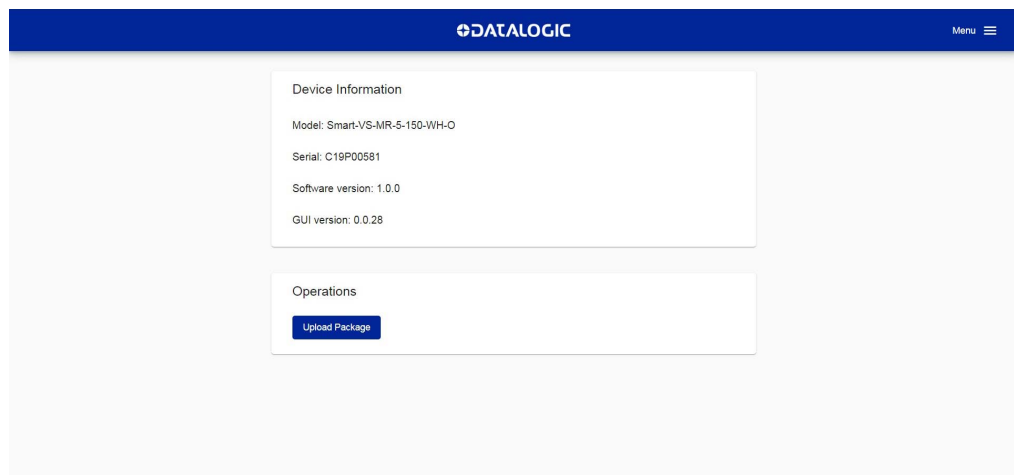

This page contains:

- **Device information:** information about the device model, serial number, software versions, and GUI version.
- **Operations:** to upgrade the device software clicking on the *Upload Package* button.

# CHAPTER 2

## INTRODUCTION

---

### PRODUCT DESCRIPTION

Smart-VS is a sensor with learning ability and easy to set, suitable for any presence and orientation object detection.

Smart-VS can solve all the applications where a very simple installing procedure is requested without the need of particularly smart camera features.

Thanks to its algorithm technology, Smart-VS is the ideal solution for application problems related to machine format adaptability and flexibility that a sensor or sensor system cannot solve as easily.

Smart-VS has been developed for different uses in the secondary packaging and automotive industries, food and beverage applications for bottling, cosmetic packaging, and all those markets where the following detection applications are needed:

Label presence



Cap orientation



Cap presence



Printing on label



## Excellent Performance

- Electronic focus control
- 50 ... 150 mm operating distance
- Image Cropping for shorter acquisition time
- Algorithm for fast and simple application setup

## Ease of Setup

- Quick installation by using a user-friendly, sensor-like HMI for easy and intuitive setup
- LED pointers for aiming
- Fast mounting accessory
- Visual Feedback to verify exact code positioning in the Field of View and to maximize performance
- Easy-to-use Web Server GUI for maintenance and job setting
- User-defined database of Image Acquisitions

## Ease of Use

- HMI interface LEDs provide operational and performance feedback
- Multi Image Acquisition Settings for higher flexibility
- Image saving and storage with buffering capability
- Diagnostic software tools

## Flexible Solution

- Complete set of accessory mounting brackets and cables
- Ethernet point-to-point communication available
- Opto-coupled, polarity insensitive inputs
- PP, NPN or PNP short-circuit protected outputs

## Industrial Strength

- Industrial compact visual sensor
- Rugged metal construction
- Sealed circular M12 connectors
- IP65 and IP67 protection class
- 50 °C max operating temperature
- Supply voltage ranges from 10 to 30 Vdc

# INDICATOR AND KEYPAD BUTTON

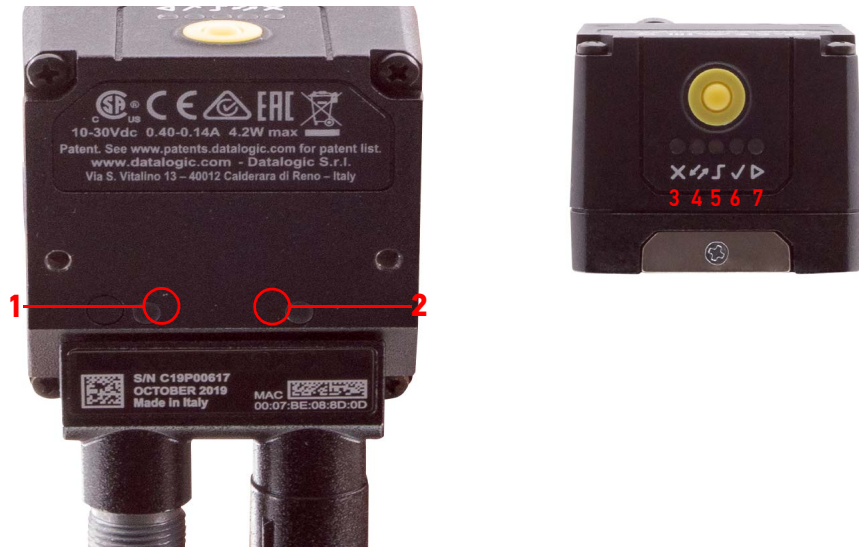

**Figure 6 - Indicators**

The following LED indicators are located on the device:

<b>PWR</b>	blue LED indicates that the device is connected to the power supply (Figure 6, 1)
<b>NET</b>	yellow LED indicates connection to the on-board Ethernet network (Figure 6, 2)

The colors and meaning of the five LEDs are illustrated in the following table:

	<b>NO GOOD</b>	red LED indicates a NO GOOD object. Blinking during Teaching (Figure 6, 3)
		for future use (Figure 6, 4)
	<b>TRIGGER</b>	yellow LED indicates trigger input status in Teach phase, and trigger received in Run phase (Figure 6, 5)
	<b>GOOD</b>	green LED indicates a GOOD object. Blinking during Teaching (Figure 6, 6)
	<b>RUN</b>	green LED indicates that the device is in Run phase. If blinking, it indicates that Teaching is required (Figure 6, 7)

During device startup (reset or restart phase), these five LEDs blink for one second.

## AIMING SYSTEM

There are two red LED pointers that project two equidistant square patterns onto the target area. The object feature to be detected should be centered between the two squares.



Figure 7 - Smart-VS Aiming LEDs

## LED SPOTS

There are two LED spots that can be activated to project light onto the target area to indicate that a GOOD or NO GOOD object has been detected.

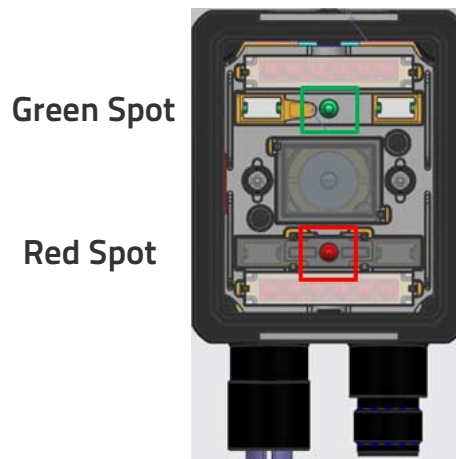

Figure 8 - Smart-VS Good / No Good LED Spots

## MODEL SELECTION AND ORDER INFORMATION

<b>Model</b>	Smart-VS-MR-5-150-WH-0
<b>Description</b>	SVS WP 150mm OUT
<b>Optics</b>	7 mm
<b>Illuminator</b>	White polarized
<b>I/O</b>	3 OUT + 2 IN + ETH
<b>Order number</b>	959971320

## INTERNAL LIGHTING SYSTEM

The Smart-VS illuminator is composed of 4 white LEDs with polarized filter.



Figure 9 - Smart-VS illuminator













## ACCESSORIES

The following accessories can be used with Smart-VS.

Accessory	Order No.
<b>Cables</b>	
CAB-GD03 M12 F/L 3M Free wires	93A050076
CAB-GD05 M12 F/L 5M Free wires	93A050077
CAB-GD10 M12 F/L 10M Free wires	93A050078
M12-IP67 GIGA Ethernet Cable X-Coded (1M)	93A050122
M12-IP67 GIGA Ethernet Cable X-Coded (3M)	93A050123
M12-IP67 GIGA Ethernet Cable X-Coded (5M)	93A050124
Adapter Cable GIGA Ethernet X-Coded M12 to RJ45	93A050128
Adapter Cable GIGA Ethernet X-Coded to Ethernet D-Coded	93A050129
<b>Bracket</b>	
BK-22-000 Fixing Bracket M220 Body	93ACC0230

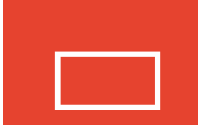
# APPLICATION EXAMPLES

Smart-VS has been developed for different uses in the secondary packaging and automotive industries, food and beverage applications for bottling, cosmetic packaging, and all those markets where the following detection applications are needed:

Application		Solved cases (OK / NOT OK)	
Label presence			
Cap orientation			
Cap presence			
Printing on label			



# CHAPTER 3

## INSTALLATION

---

### PACKAGE CONTENTS

Verify that the Smart-VS device and all the parts supplied with the equipment are present and intact when opening the packaging; the list of parts includes:

- Smart-VS (w/connector plug/cover)
- Quick Reference Guide
- Mounting Kit
  - Mounting Screws (2)
  - Washers (2)
  - Mounting Bracket

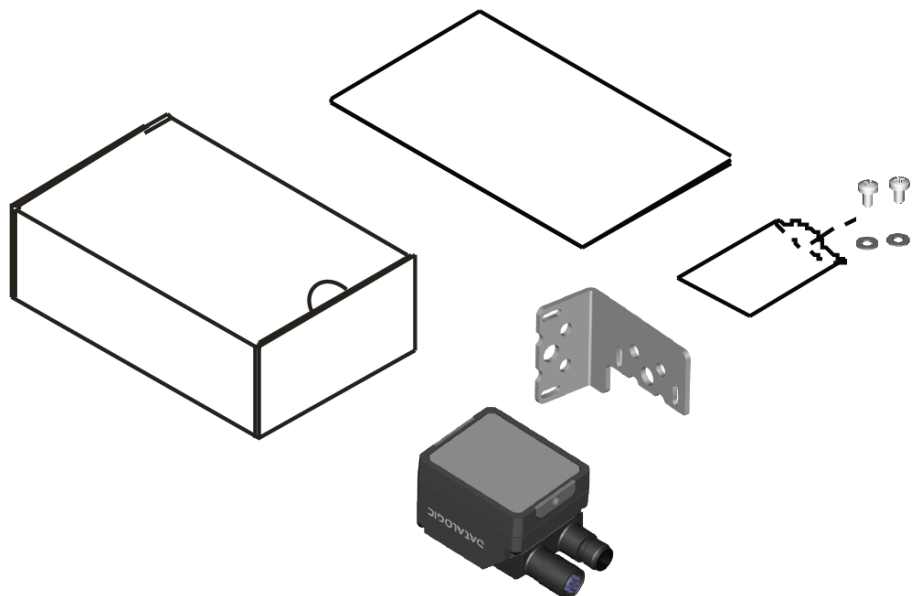

**Figure 10 - Package Contents**

The Ethernet sealing connector plug provides IP67 protection when Ethernet is not used.

## MECHANICAL DIMENSIONS

Smart-VS can be installed to operate in different positions. The two screw holes (M3 x 4mm depth) on the body of the device are for mechanical fixture.

The diagrams below give the overall dimensions of the device and may be used for its installation.

Refer to page 24 for various mounting solutions and correct positioning.

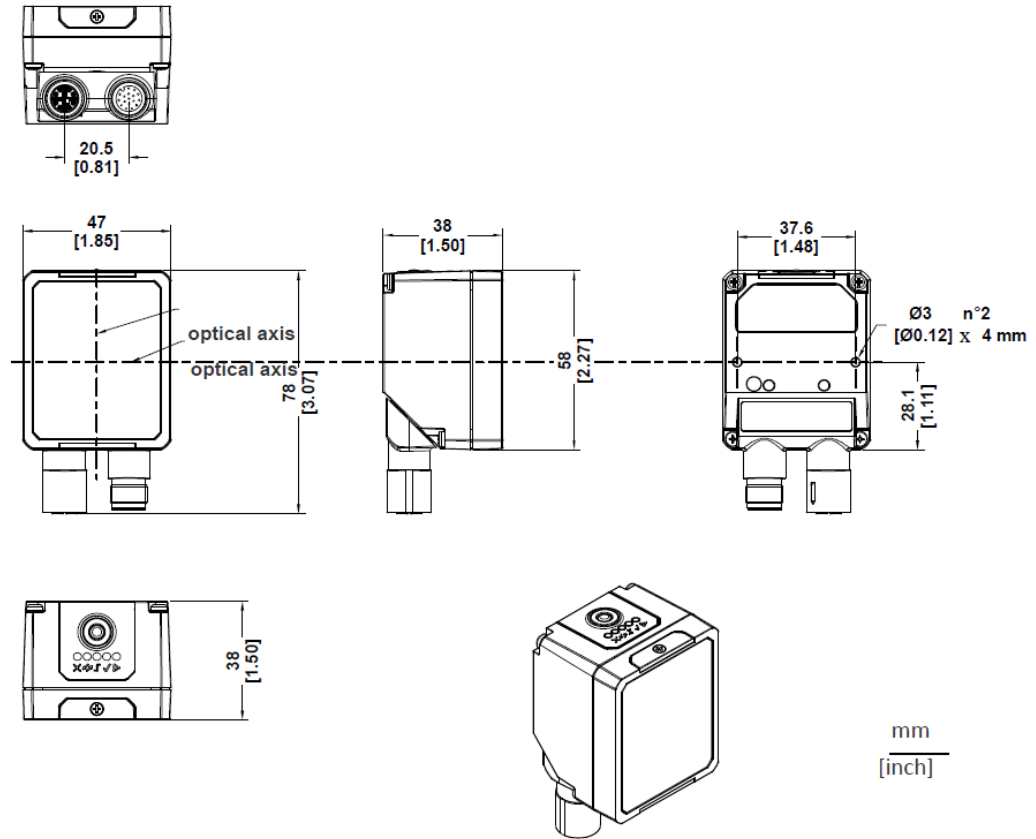

Figure 11 - Overall Dimensions; Connector at 0°

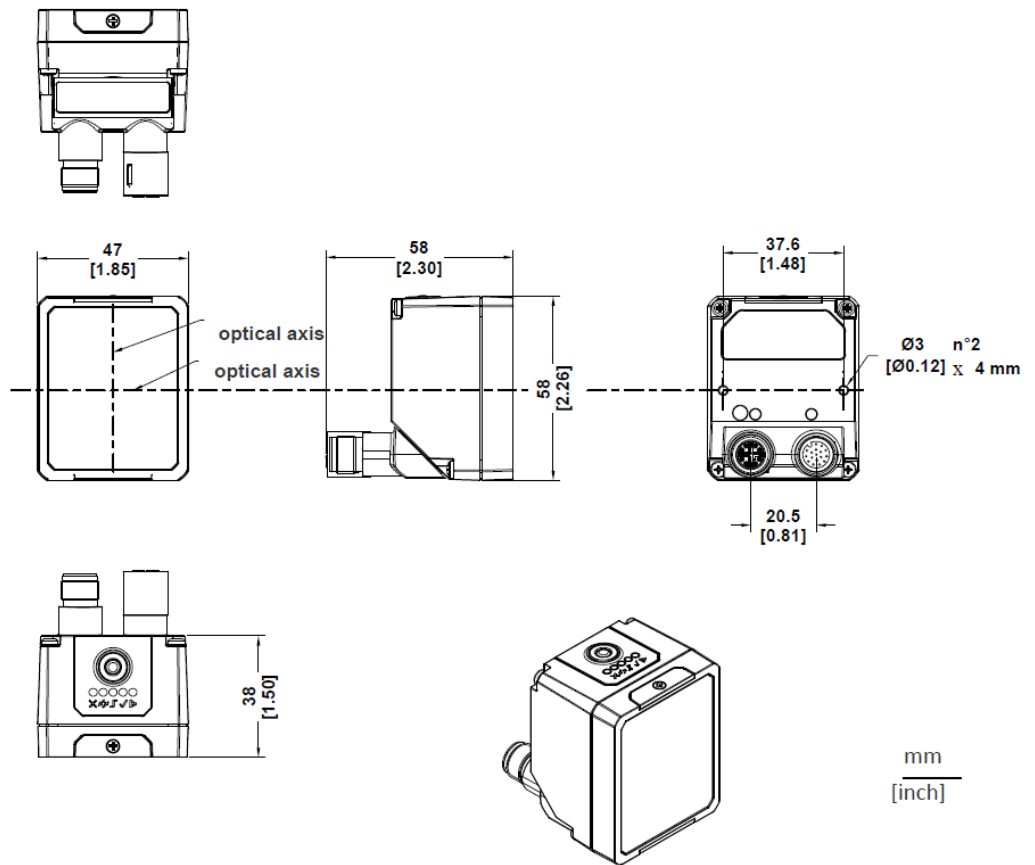

Figure 12 - Overall Dimensions; Connector at 90°

## MOUNTING AND POSITIONING SMART-VS

Using the Smart-VS mounting brackets you can obtain rotation on the various axes of the device as shown in the diagram below:

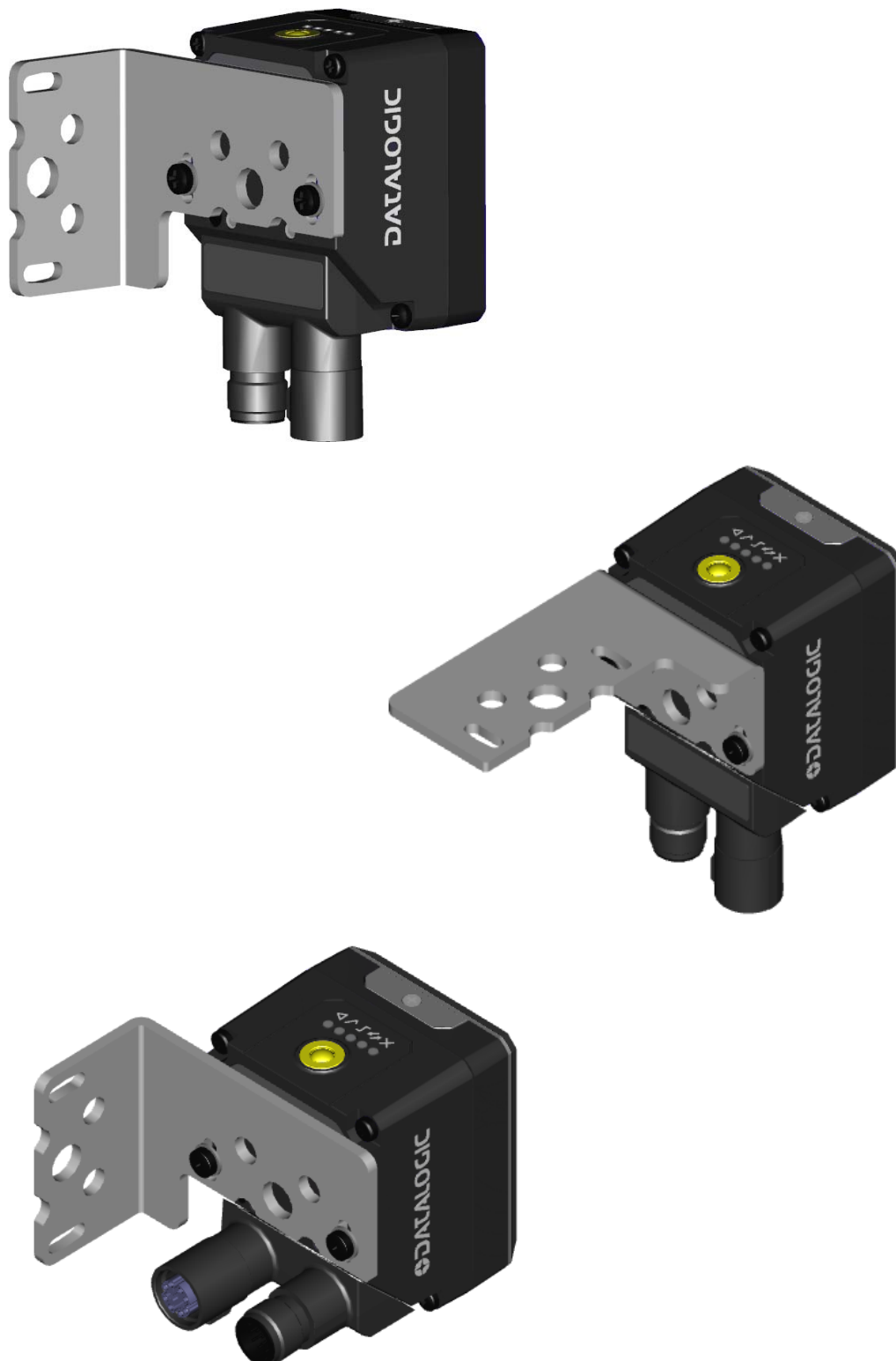

Figure 13 - Positioning with Mounting Bracket

# CHAPTER 4

## ELECTRICAL CONNECTIONS

Smart-VS can be connected through one of the available CAB-GDxx accessory cables. These terminate in an M12 17-pin connector on the Smart-VS side and 17 free leads on the other side. CAB-GDxx wires have the following functionalities:

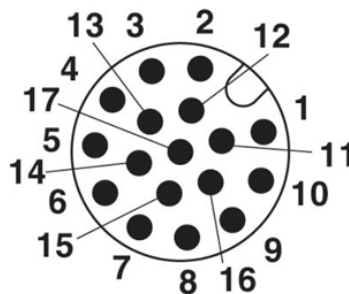

Figure 14 - M12 17-pin Power, COM, and I/O Connector

POWER, COM, AND I/O CONNECTOR PINOUT			
PIN	NAME	COLOR	DESCRIPTION
1	Vdc	Brown	Power supply input voltage +
2	GND	Blue	Power supply input voltage -
Connector case	Chassis		Connector case provides electrical connection to chassis
6	I1A	Yellow	I1A Trigger Input A (polarity insensitive)
5	I1B	Pink	I1B Trigger Input B (polarity insensitive)
13	I2A	White/Green	I2A Remote Teach A (polarity insensitive)
3	I2B	White	I2B Remote Teach B (polarity insensitive)
9	O1	Red	Data Valid PP
8	O2	Gray	GOOD Output PP
16	O3	Yellow/Brown	NO GOOD Output PP



**NOTE**

It is recommended to trim out the unused wires.

# POWER SUPPLY

The power must be between 10 and 30 Vdc only.

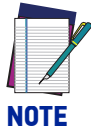

**NOTE**

**Each time the Smart-VS is powered on, the electronic focus motor system does extra work for system checking and setup. It is recommended to limit power cycles to a few times per day.**

# INPUTS

There are two optocoupled polarity insensitive inputs available on the reader: Input 1 (External Trigger) and Input 2 (Remote Button).

The External Trigger is necessary to start acquiring and processing images.

The Remote Button installation is recommended in cases where the device is not accessible and, in general, to have easier access to the Teaching function.

The electrical features of both inputs are:

$$V_{AB} = 30 \text{ Vdc max.}$$

$$I_{IN} = 10 \text{ mA max.}$$

The active state of these inputs are selected in software.

An anti-disturbance filter, by default, is implemented in software on both inputs. The value can be changed through the software parameter Debounce Filter. See "[Settings](#)" on page 13 or refer to the Settings section of the Smart-VS WebApp User's Guide for further details on these parameters.

These inputs are optocoupled and can be driven by both NPN and PNP type commands.

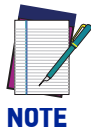

**NOTE**

**Polarity insensitive inputs assure full functionality even if pins A and B are exchanged.**

# Trigger and external push-button connection

The following table shows how to connect the Trigger and Remote inputs.

	RECOMMENDED CONNECTION	NOTES
<b>External Push-Button</b>		<p>A Normally Open push-button is needed.</p> <p>I2A and I2B are polarity insensitive and can be inverted.</p>
<b>Trigger signal from PNP device</b>		<p>Connect the output of the PNP trigger device to I1A and the GND supply rail to I1B.</p> <p>I1A and I1B are polarity insensitive and can be inverted.</p>
<b>Trigger signal from NPN device</b>		<p>Connect the output of the NPN trigger device to I1B and the VDC supply rail to I1A.</p> <p>I1A and I1B are polarity insensitive and can be inverted.</p>

# OUTPUTS

The three outputs can be configured as NPN, PNP, and Push-Pull (default setting). They are short-circuit protected and the maximum load is 100 mA.

Output 2 and Output 3 serve as GOOD and NO GOOD Object signals. By default, they stay active for 10 ms.

Output 1 serves as Data Valid signal. It is activated 1 ms after the GOOD or NO GOOD Object signal activation, and deactivated 1 ms before the GOOD or NO GOOD Object signal deactivation.

The output activation length can be set via Smart-VS WebApp on the Settings page.

## Digital I/O diagram

Image acquisition starts on the Leading edge of the input trigger signal (default, can be changed to Trailing edge via Smart-VS WebApp).

A Debounce time can be set on the Smart-VS WebApp to reject noisy trigger signals.

Each trigger event corresponds to a Data Valid signal indicating that the Output signals can be sampled.

The inspection result, i.e. a GOOD or NO GOOD object detected, is always available after 50 ms from trigger (response time).

If a Debounce time greater than zero has been set, the device response time is 50 ms plus the trigger Debounce time.

Overrun conditions (see "Troubleshooting" on page 37) are signaled raising both the GOOD and NO GOOD output signals.



**Although not strictly necessary, it is recommended to connect and process all the output signals in order to have complete system information for diagnostics and troubleshooting.**

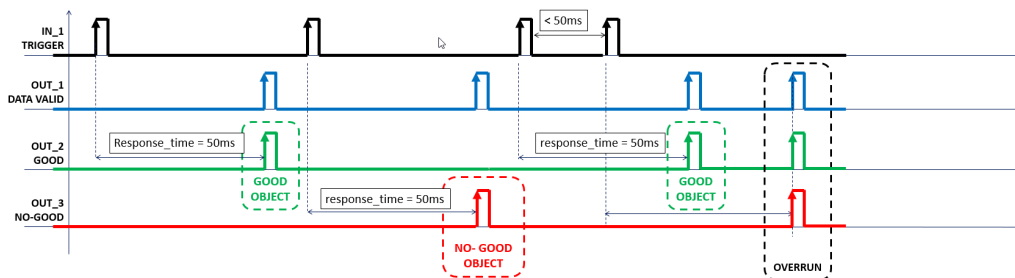

## Data Valid timing details

The Data Valid signal is raised 1 ms after the GOOD or NO GOOD signal is raised.

It is lowered 1 ms before the GOOD or NO GOOD signal is lowered.

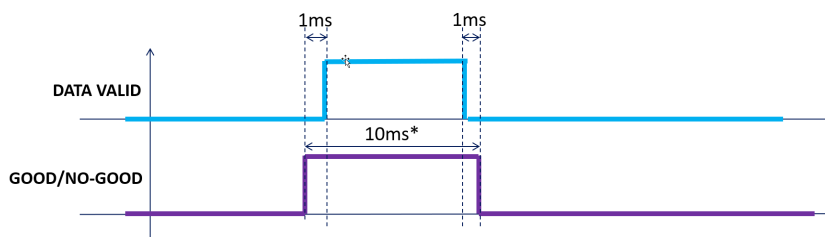

\*default, adjustable via Smart-VS WebApp

## ON-BOARD ETHERNET INTERFACE

The on-board Ethernet Interface can be used for WebApp access and Telnet communication.

The WebApp is accessible opening an Internet browser (Google Chrome is recommended) and entering the device IP address 192.168.3.100 in the address bar.

Telnet communication can be established by connecting to device IP at port 23.

A **CAB-ETH-X-M0x** cable can be used to connect to a host device.



### NOTE

**Point-to-point connection is highly recommended.**

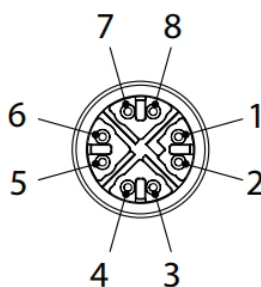

**Figure 15 - M12 8-pin Standard Ethernet Network Connector**

STANDARD ETHERNET NETWORK CONNECTOR PINOUT		
PIN	NAME	DESCRIPTION
1	TX+	Transmit data (positive pin)
2	TX-	Transmit data (negative pin)
3	RX+	Receive data (positive pin)
4	RX-	Receive data (negative pin)
5	nc	Not connected
6	nc	Not connected
7	nc	Not connected
8	nc	Not connected



# CHAPTER 5

## TYPICAL LAYOUTS

---

The following typical layouts refer to system hardware configurations. Dotted lines in the figures refer to optional hardware configurations within the particular layout.



**NOTE**

**All software configurations are made through the Smart-VS WebApp, which connects to the reader through the on-board Ethernet interface.**

### SENSOR-LIKE SETUP

The Smart-VS is connected directly to the machine control system.

An optional push-button is recommended if Teaching is frequently performed for product batch changes or if the device is not easily accessible.

A presence sensor or the machine electrical phase is necessary to trigger image acquisition.

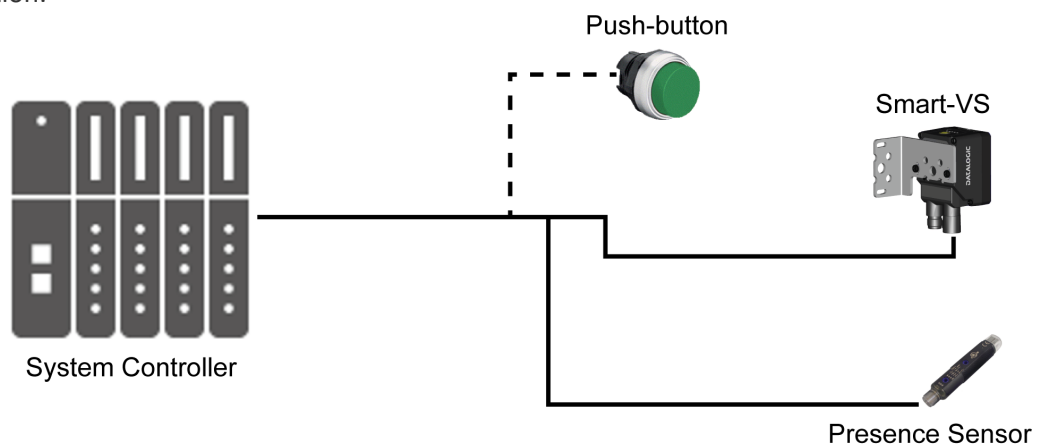

**Figure 16 - Sensor-like Setup**

## WEBAPP FOR INITIAL CONFIGURATION AND OCCASIONAL MONITORING

In addition to the previous setup, a PC can be connected via Ethernet for initial configuration and occasional monitoring.

A point-to-point Ethernet connection is recommended.

A presence sensor or the machine electrical phase is necessary to trigger image acquisition.

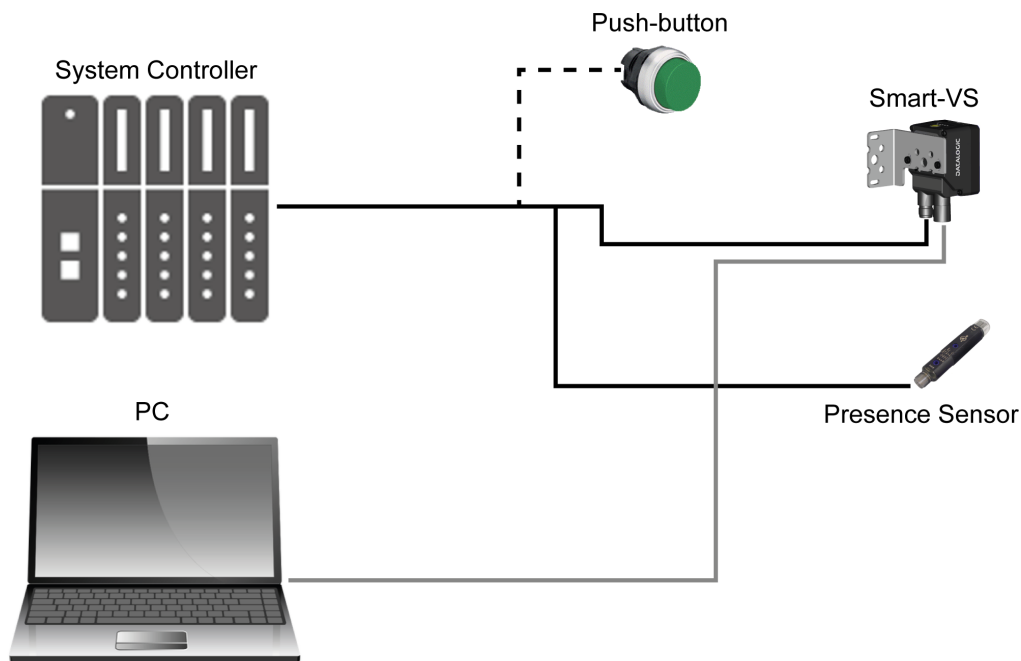

Figure 17 - WebApp Setup

## SETUP WITH TELNET COMMUNICATION FOR JOB SWITCHING

If more than one Job is needed, Job switching can be done via Telnet communication. An Ethernet switch can be used to ease the connection, but a dedicated LAN is still recommended, since the Smart-VS is configured with a fixed IP address. A presence sensor or the machine electrical phase is necessary to trigger image acquisition.

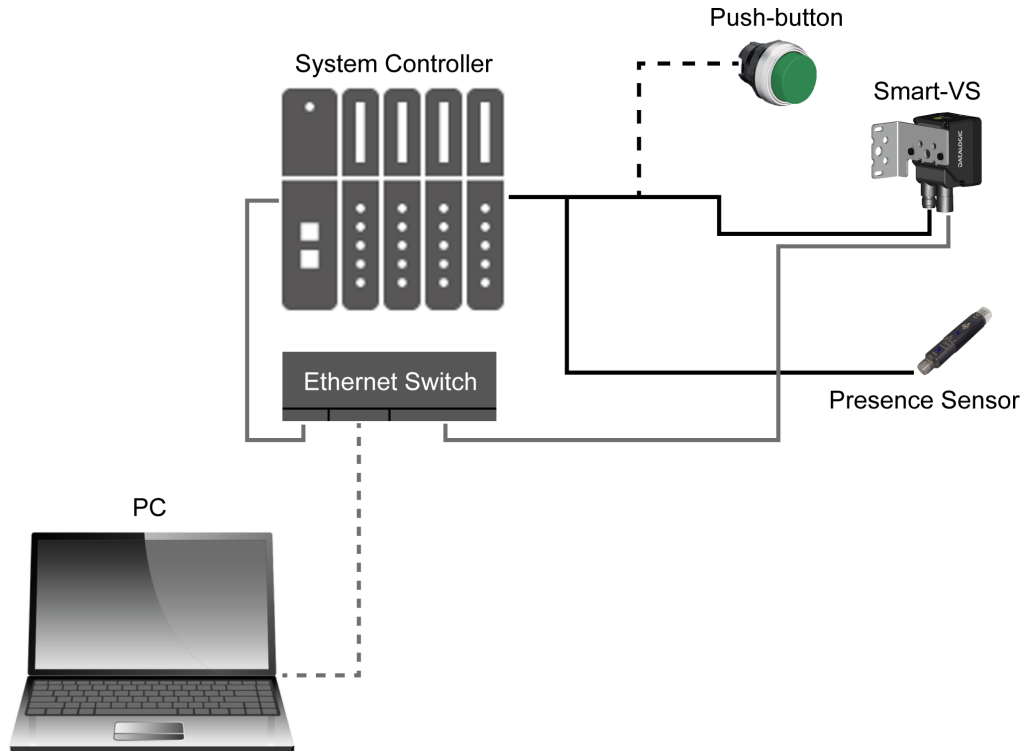

Figure 18 - Telnet Setup

For more information on Job switching via Telnet, refer to "Job Switching via Telnet Communication" on page 35.

# CHAPTER 6

## READING FEATURES

### FOV CALCULATION

Use the data in the following table to calculate the FOV for your application, referring to Figure 19 and the formula below.

$d_0$	View Angle Horizontal	View Angle Vertical	View Angle Diagonal	Min Reading Distance
11 mm	19°	14.5°	24°	50 mm

The viewing angle has a tolerance of  $\pm 1^\circ$  depending on the reading distance.

$$\text{FOV}_x = 2 [ (d + d_0) * \tan (\alpha_x/2) ]$$

where:

$\text{FOV}_x$  = horizontal, vertical or diagonal FOV

$\alpha_x$  = horizontal, vertical or diagonal viewing angles.

$d$  = reading distance (in mm) from window surface to code surface

$d_0$  = offset (in mm) from center of lens to external window surface

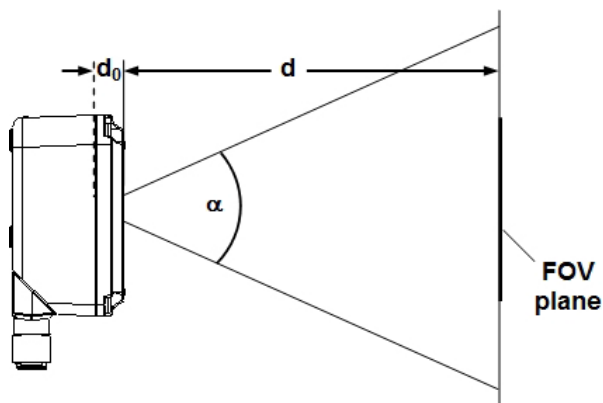

Figure 19 - Reading Distance References

#### Example

The FOV at a reading distance of 100 mm is:

$$\text{FOV}_H = 2 [ (100 \text{ mm} + 11 \text{ mm}) * \tan (19^\circ/2) ] \cong 37 \text{ mm}$$

$$\text{FOV}_V = 2 [ (100 \text{ mm} + 11 \text{ mm}) * \tan (14.5^\circ/2) ] \cong 28 \text{ mm}$$

# DETECTION DIAGRAM

The following diagram shows the maximum obtainable Field of View for object inspection.



## NOTE

All features of interest related to the object inspection should be included in the Field of View.

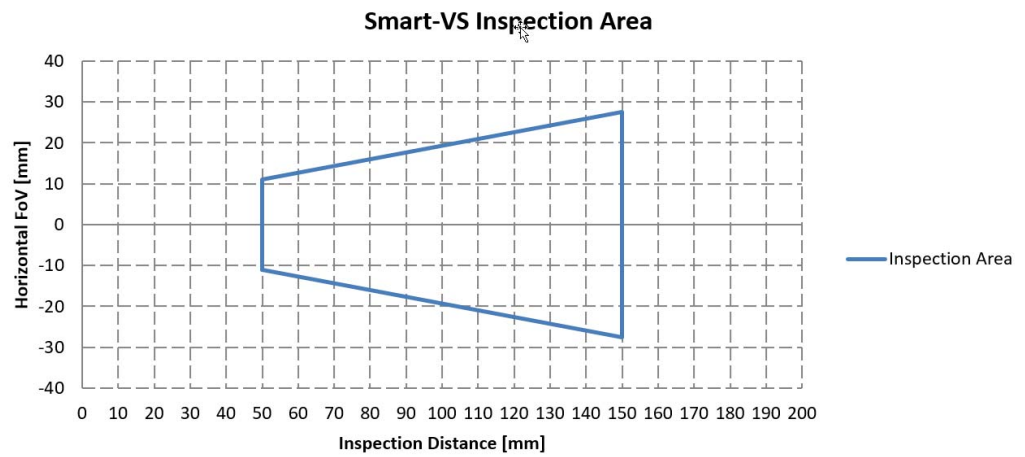

# CHAPTER 7

## MULTI JOB CONFIGURATION

---

The Smart-VS can manage Multi Job operations. This feature is useful when different object batches must be inspected within a single machine.

Up to 32 Jobs can be stored in the device internal memory.

Job switching can be performed either via Smart-VS WebApp or Telnet communication.

### JOB SWITCHING VIA SMART-VS WEBAPP

To recall a Job in the Smart-VS WebApp, go to the Monitoring page and select the Job ID from the *Current Job* list.

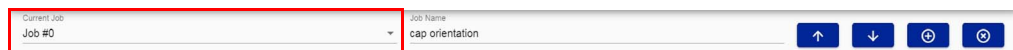

Confirm the running Job by clicking on the *Save and Play* button before leaving the page. This will also be the Job loaded at the next system startup.



## JOB SWITCHING VIA TELNET COMMUNICATION

Jobs can also be recalled via Ethernet connection using a Telnet communication.

Open a TCP/IP Telnet session using a Telnet client with the following parameters:

- IP: 192.168.3.100
- Port: 23

```
Welcome at Smart-VS telnet server
Smart-VS>
```

The following commands are available to switch Jobs and retrieve information on the running Job:

COMMAND	DESCRIPTION	EXAMPLE	OUTPUT MESSAGE
<code>job load &lt;job_ID&gt;</code>	Load the job_ID (0 to 31). Changes will be applied to the next system startup.	<code>job load 6</code>	DONE; FAIL;
<code>job status</code>	Retrieve information on the current Job.	<code>job status</code>	Current loaded bank: <job_ID> Current startup bank: <job_ID>

# CHAPTER 8

## MAINTENANCE

---

### CLEANING

Clean the lens cover periodically for continued correct operation of the device. See "General View" on page xi.

Dust, dirt, etc. on the lens cover may alter the device performance.

Repeat the operation frequently in particularly dirty environments.

Use soft material and alcohol to clean the lens cover and avoid any abrasive substances.



# CHAPTER 9

## TROUBLESHOOTING

TROUBLESHOOTING GUIDE	
PROBLEM	SUGGESTION
Overrun	<p>Overrun occurrences are mostly due to a noisy trigger signal and/or a too fast sequence of trigger events (e.g. more than two events every 50 ms).</p> <p>Choose a proper Debounce filter time and/or adjust the line speed to have 20 pieces per second.</p>
The Trigger LED does not light up when the object passes in front of the sensor	<ul style="list-style-type: none"> <li>• In case of PNP signal, check that one of the two trigger inputs (I1A or I1B) is connected to the signal coming from the sensor (or PLC) and the other input is connected to 0Vdc.</li> <li>• In case of NPN signal, check that one of the two trigger inputs (I1A or I1B) is connected to the signal coming from the sensor (or PLC) and the other input is connected to +Vdc.</li> <li>• Check that the trigger sensor switches regularly when the object passes through.</li> <li>• Check that the Trigger Debounce is not set too high.</li> </ul>
The Remote input signal does not start the Teaching procedure	<ul style="list-style-type: none"> <li>• In case of PNP signal, check that one of the two Remote inputs (I2A or I2B) is connected to the signal coming from the button (or PLC) and the other input is connected to 0Vdc.</li> <li>• In case of NPN signal, check that one of the two Remote inputs (I2A or I2B) is connected to the signal coming from the button (or PLC) and the other input is connected to +Vdc.</li> <li>• Check the correct operation of the button using a multimeter.</li> <li>• Check that the Button Debounce is not set too high.</li> </ul>
The PLC does not receive GOOD or NO GOOD signals from the Smart-VS sensor	<ul style="list-style-type: none"> <li>• Check that the GOOD object and NO GOOD object LEDs light up correctly.</li> <li>• If the PLC requires a PNP signal, check that the Smart-VS outputs are set as Push-Pull or PNP.</li> <li>• If the PLC requires a NPN signal, check that the Smart-VS outputs are set as Push-Pull or NPN.</li> </ul>
The Power On LED is off	<ul style="list-style-type: none"> <li>• Check that Pin 1 (brown wire) is connected to +Vdc and Pin 2 (blue wire) is connected to 0Vdc.</li> <li>• Use a multimeter to check that the power supply voltage is 10 to 30 Vdc (see "Technical Features" on page 38).</li> </ul>

# APPENDIX A

## TECHNICAL FEATURES

---

ELECTRICAL FEATURES	
<b>Power</b>	
Supply Voltage	10 to 30 Vdc
Consumption	0.40 - 0.14 A (4.2 W) max
<b>Communication Interfaces</b>	
Ethernet (embedded) <sup>a</sup>	10/100 Mbit/s
<b>Inputs</b>	
	Opto-coupled and polarity insensitive
Max. Voltage	30 Vdc
Max. Input Current	10 mA
<b>Outputs</b>	
	PP, NPN or PNP short circuit protected;
Max. Output Voltage Drop	3V
V <sub>OUT</sub> HIGH (Max. / Min.)	V <sub>supply</sub> / V <sub>supply</sub> - 3V
V <sub>OUT</sub> LOW (Max. / Min.)	3V / 0V
I <sub>LOAD</sub> Max.	100 mA
GOOD and NO GOOD output response time	50 ms from input trigger

- a. The embedded Ethernet interface is intended for configuration only through connection to the device IP address 192.168.3.100. Point-to-Point connection is recommended.

OPTICAL FEATURES	
Operating Distance	50 - 150 mm
View Angle	19°

## ENVIRONMENTAL FEATURES

<b>Operating Temperature <sup>a</sup></b>	-10 to 50 °C (14 to 122 °F)
<b>Storage Temperature</b>	-20 to 70 °C (-4 to 158 °F)
<b>Max. Humidity</b>	90% non condensing
<b>Vibration Resistance EN 60068-2-6</b>	14 mm @ 2 to 10 Hz; 1.5 mm @ 13 to 55 Hz; 2 g @ 70 to 500 Hz; 2 hours on each axis
<b>Shock Resistance EN 60068-2-27</b>	30g; 11 ms; 3 shocks on each axis
<b>Protection Class <sup>b</sup> EN 60529</b>	IP65 and IP67

- a. high ambient temperature applications should use metal mounting bracket for heat dissipation.
- b. when correctly connected (fully tightened) to IP67 cables with seals.

## PHYSICAL FEATURES

<b>Dimensions</b>	H x W x L
Smart-VS with connector at 0°	78 x 47 x 38 mm (3.1 x 1.9 x 1.5 in)
Smart-VS with connector at 90°	58 x 47 x 58 mm (2.3 x 1.9 x 2.3 in)
<b>Weight</b>	173 g (6.1 oz)
<b>Material</b>	Aluminum with PMMA protective window cover

© 2020 Datalogic S.p.A. and /or its affiliates • All rights reserved • Without limiting the rights under copyright, no part of this documentation may be reproduced, stored in or introduced into a retrieval system, or transmitted in any form or by any means, or for any purpose, without the express written permission of Datalogic S.p.A. and/or its affiliates • Datalogic and the Datalogic logo are registered trademarks of Datalogic S.p.A. in many countries, including the U.S. and the E.U.



**Datalogic S.r.l.**

Via S. Vitalino, 13 | 40012 Calderara di Reno | Bologna - Italy  
Tel. +39 051 3147011 | Fax +39 051 3147205



821006970

(Rev A)

May 2020