

S40 SERIES

The photoelectric sensors of the **S40** series, in the innovative miniature housing, offer all the main optic functions with the advantages of microprocessor control and automatic Teach-in and Remote setting with EASYtouch™ procedure.

The series includes different models: 30 cm diffuse proximity and 10 cm background suppression, 4 m retroreflex, 3 m polarised retroreflex, or 0.7 m version for the detection of transparent glass or PET objects, 6 m through beam models, all with visible red emission.

The laser emission is available for retroreflex, proximity and background suppression, offering very high resolution detection.

The sensitivity and operating distance setting are obtained by simply pressing the button, or by cable to allow remote control and the mounting in small or difficult to reach areas.

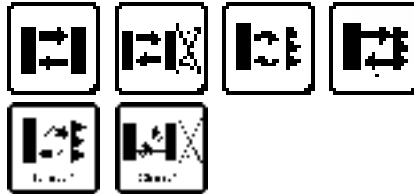

HIGHLIGHTS

- EASYtouch™ microprocessor Teach-in and Remote setting
- Laser retroreflex, proximity and background suppression
- Cable or M8 connection, NPN or PNP
- ABS housing with IP67 protection

APPLICATIONS

Automotive





Beverage & Bottling



Packaging lines



TECHNICAL DATA

Power supply:	10 ... 30 Vdc, reverse polarity protection
Consumption:	35 mA max.
Light emission:	red LED 660 nm, red laser 650 nm
Diffuse proximity operating distance:	0.5 ... 30 cm
Laser diffuse proximity op. distance:	4 ... 15 cm
Laser proximity resolution:	0.2 mm (on focus point)
Background suppression op. distance:	15 ... 100 mm
Laser background suppr. op. distance:	20 ... 60 mm
Laser background suppr. resolution:	0.2 mm (on focus point)
Background suppr. white/grey diff.:	7%
Polarised retroreflex operating distance:	0.1 ... 2.5 m (on R2)
Laser polarised retroreflex op. distance:	0.1 ... 6 m (on R2)
Laser retroreflex resolution:	1 mm (on focus point)
Retroreflex transparents op. distance:	0.1 ... 0.7 m (on R2)
Setting:	SET push-button Remote by cable
Indicators:	yellow OUTPUT LED green POWER LED (G vers.) green READY/ERROR LED
Output type:	NPN or PNP, Rpull-down/up 22 kW
Saturation voltage:	2.4 V max.
Output current:	100 mA max, short-circuit protection
Response time:	0.5 ms 125 µs (laser B03 and C03 versions)
Switching frequency:	1 kHz max. 4 kHz (laser B03 and C03 versions)
Operating mode:	dark/light programmable
Connection:	4-pole M8 connector 2 m Ø 3.5 mm cable
Laser safety class:	class II
Electrical protection:	class 2
Mechanical protection:	IP67
Housing material:	ABS
Lens material:	PMMA plastic
Weight:	10 g max. (connector vers.) 40 g max. (cable vers.)
Operating temperature:	-20 ... +60°C
Storage temperature:	-20 ... +80°C
Reference standard:	EN 60947-5-2, EN 60825-1
Certifications:	 

The operating distances indicate the detection distance with excess gain 2.

CONNECTIONS

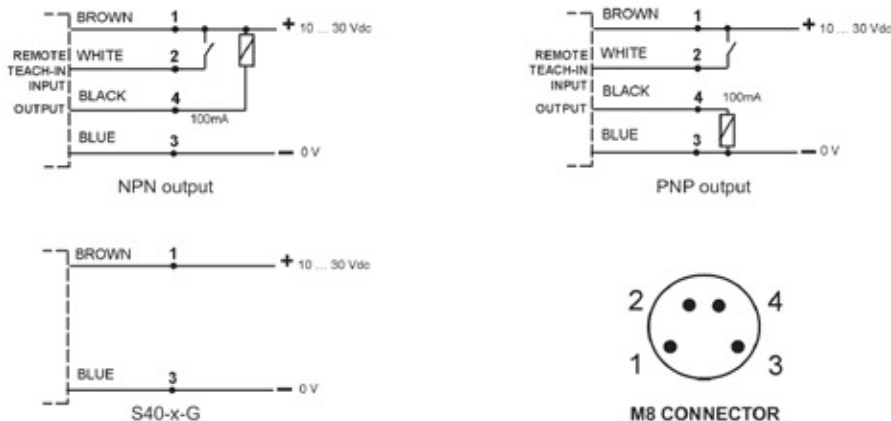

DETECTION DIAGRAMS

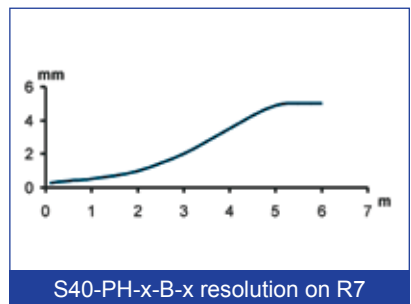
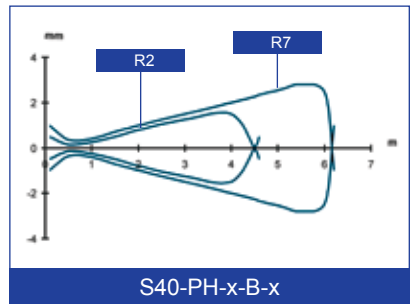
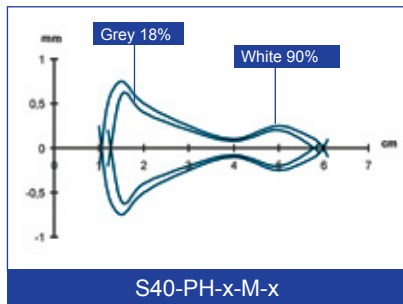
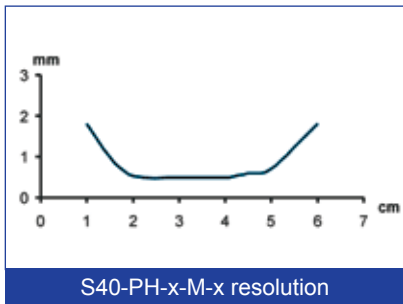
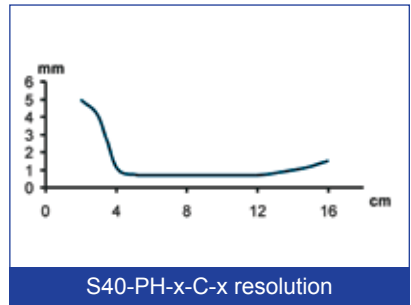
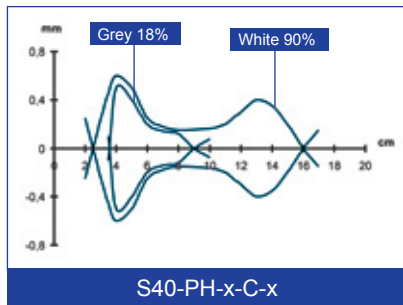
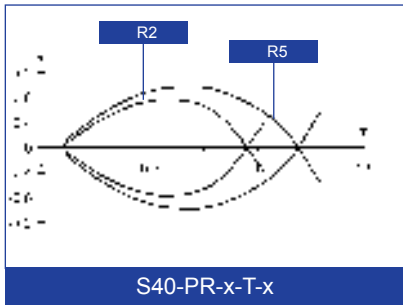
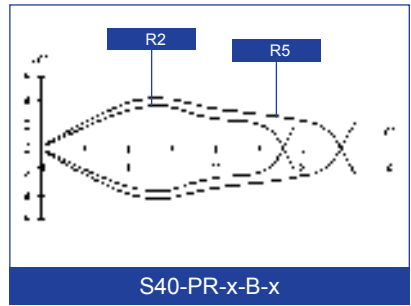
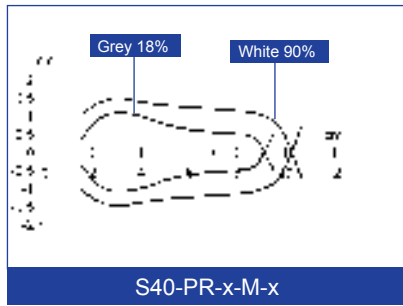
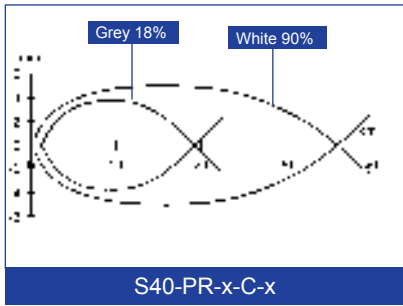

The detection diagrams indicate the typical operating distance with excess gain 1.

DIMENSIONS

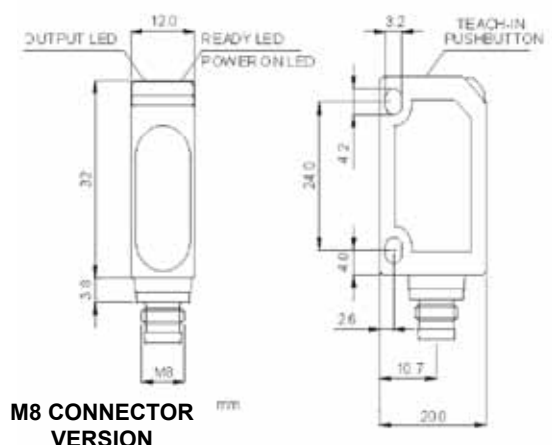
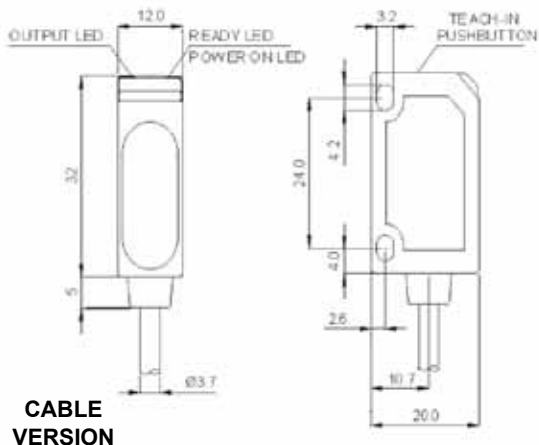

MODEL SELECTION AND ORDER INFORMATION

MODEL	OPTIC FUNCTION	CONNECTION	OUTPUT	CODE N°
S40-PR-2-B03-NH	polarised retroreflex	2 m cable	NPN	950401360
S40-PR-2-B03-PH	polarised retroreflex	2 m cable	PNP	950401300
S40-PR-2-C03-NH	diffuse proximity	2 m cable	NPN	950401370
S40-PR-2-C03-PH	diffuse proximity	2 m cable	PNP	950401310
S40-PR-2-M03-NH	background suppression	2 m cable	NPN	950401380
S40-PR-2-M03-PH	background suppression	2 m cable	PNP	950401320
S40-PR-2-T03-NH	retroreflex for transparents	2 m cable	NPN	950401410
S40-PR-2-T03-PH	retroreflex for transparents	2 m cable	PNP	950401350
S40-PR-5-B03-NH	polarised retroreflex	M8 connector	NPN	950401480
S40-PR-5-B03-PH	polarised retroreflex	M8 connector	PNP	950401420
S40-PR-5-C03-NH	diffuse proximity	M8 connector	NPN	950401490
S40-PR-5-C03-PH	diffuse proximity	M8 connector	PNP	950401430
S40-PR-5-M03-NH	background suppression	M8 connector	NPN	950401500
S40-PR-5-M03-PH	background suppression	M8 connector	PNP	950401440
S40-PR-5-T03-NH	retroreflex for transparents	M8 connector	NPN	950401530
S40-PR-5-T03-PH	retroreflex for transparents	M8 connector	PNP	950401470
S40-PH-5-B03-NH	laser polarised retroreflex	M8 connector	NPN	950401240
S40-PH-5-B03-PH	laser polarised retroreflex	M8 connector	PNP	950401250
S40-PH-5-C03-NH	laser diffuse proximity	M8 connector	NPN	950401260
S40-PH-5-C03-PH	laser diffuse proximity	M8 connector	PNP	950401270
S40-PH-5-M03-NH	laser background suppression	M8 connector	NPN	950401280
S40-PH-5-M03-PH	laser background suppression	M8 connector	PNP	950401290

ACCESSORY SELECTION AND ORDER INFORMATION

MODEL	DESCRIPTION	ORDER N°
ST-505	1 pc fixing bracket	95ACC2800

The company endeavours to continuously improve and renew its products; for this reason the technical data and contents of this catalogue may undergo variations without prior notice. For correct installation and use, the company can guarantee only the data indicated in the instruction manual supplied with the products.